

INSTALLATION MANUAL

MONTAGEANLEITUNG
INSTRUCTIONS DE MONTAGE
ISTRUZIONI PER IL MONTAGGIO

**KNOW
HOW**
INSTALLED

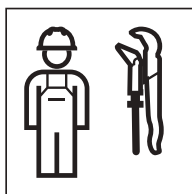

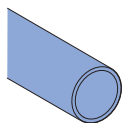

→ **1 A**  2

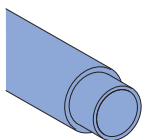

→ **1 B**  4

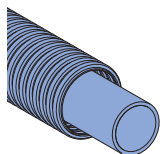

→ **1 C**  5



1

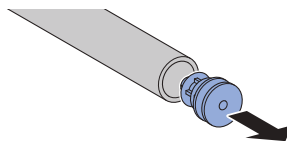

2

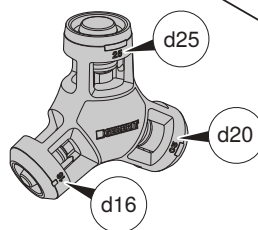
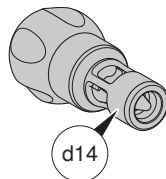
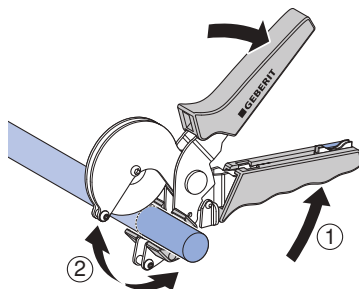

3

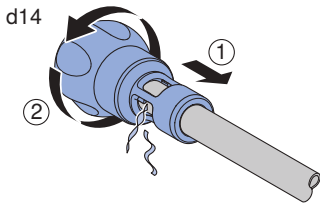

d16-25

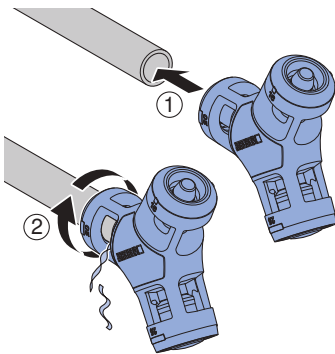

4

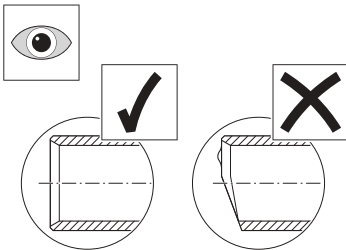

5

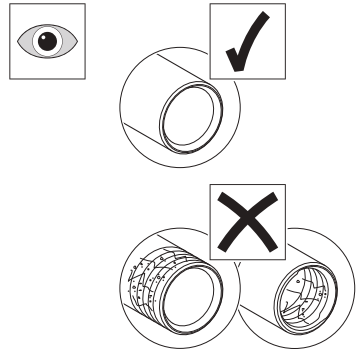

1 B

1

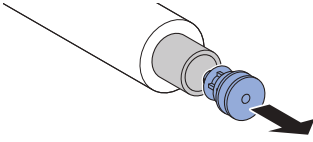

2

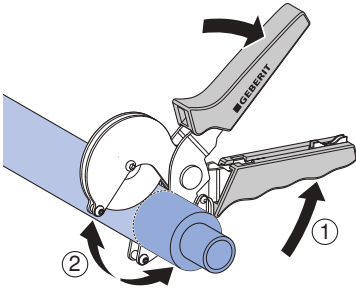

3

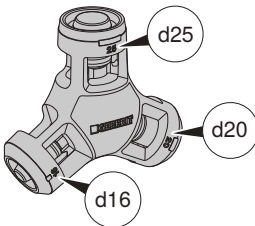
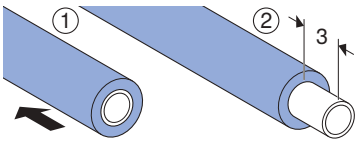

4

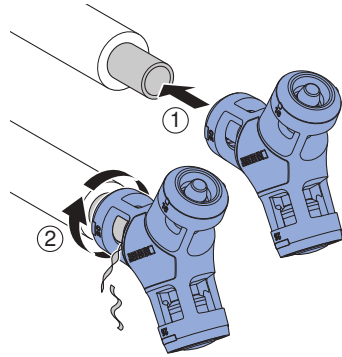

5

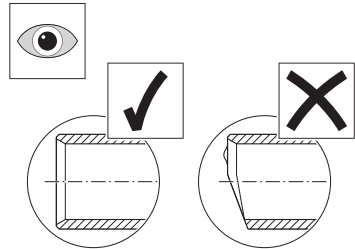

6

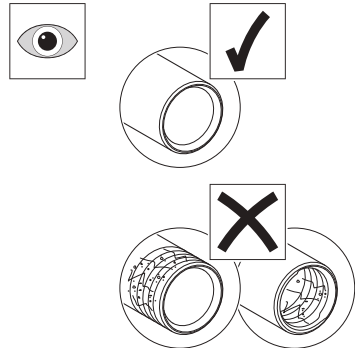

1 C

1

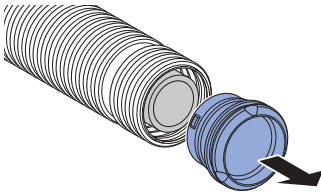

2

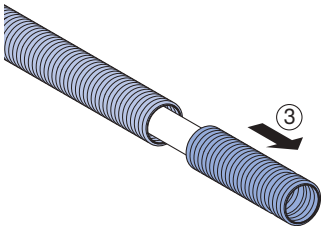
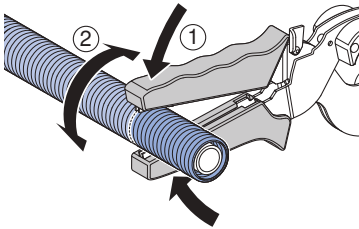

3

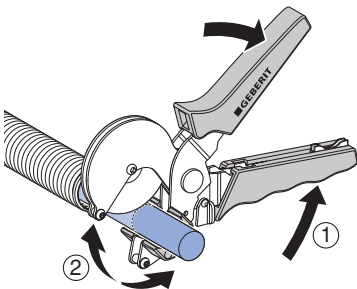

i

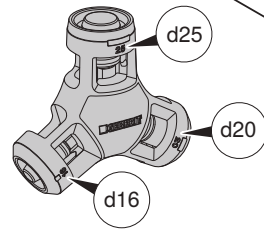
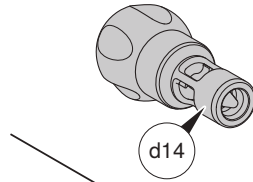

4

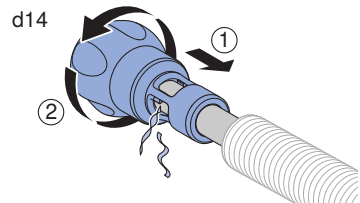

d16-25

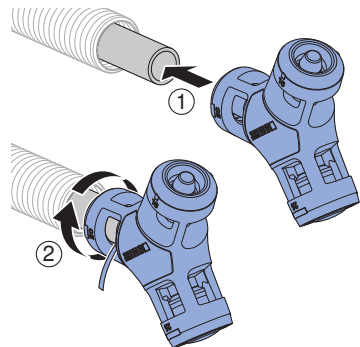

5

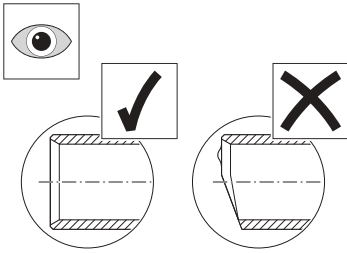

6

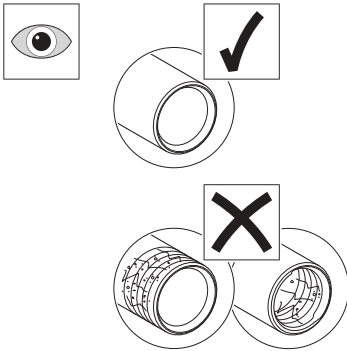

2

1

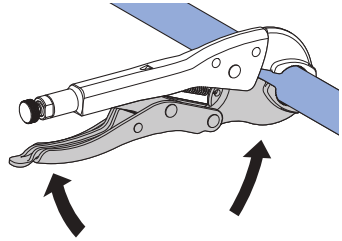

i

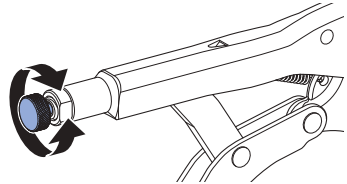

2

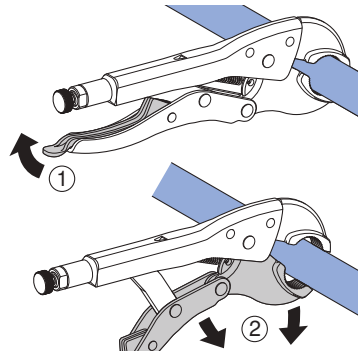

3

1

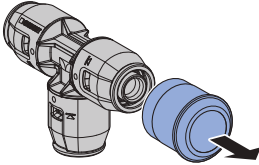

2

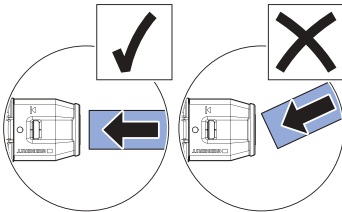
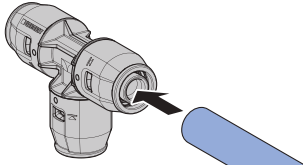
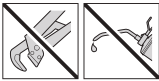

3

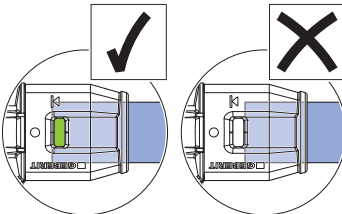
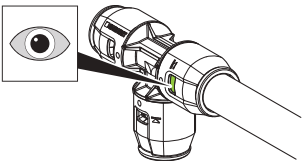



Geberit International AG
Schachenstrasse 77, CH-8645 Jona
documentation@geberit.com
www.geberit.com